



De Rosis

SKIN\_PREVIEW 2018



# SKIN





new







# SKIN







# SKIN



## TECHNICALS

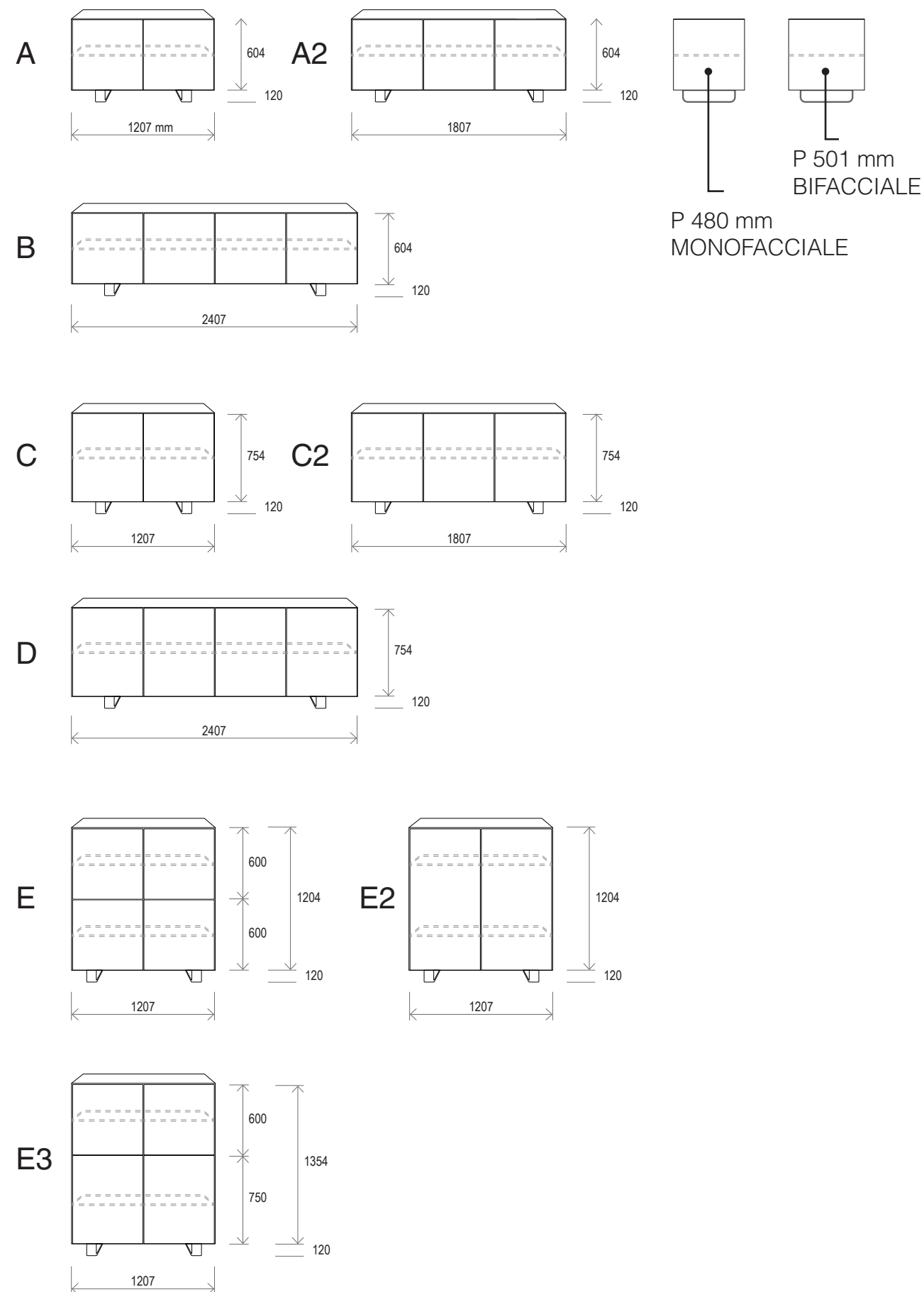

Gli elementi graficati sono rappresentati con il basamento SKIN H120 mm; la versione bifacciale è fornita di una schiena singola per modulo.

## TECHNICALS

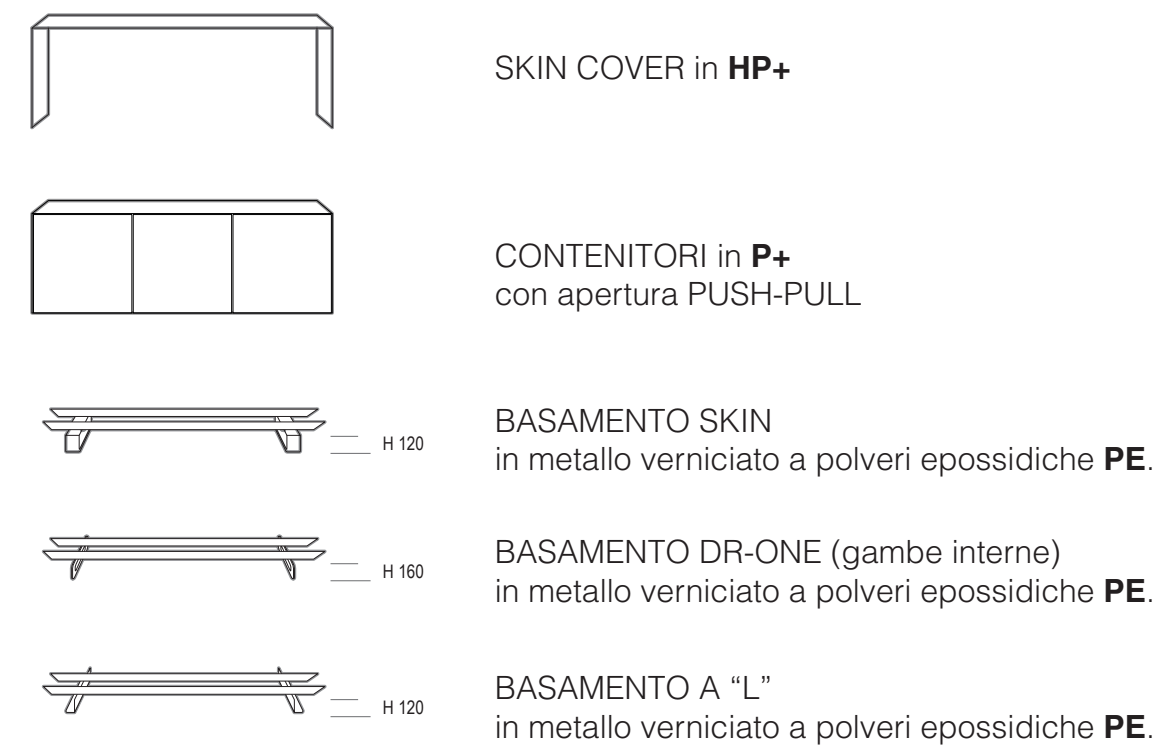

## AVVERTENZE

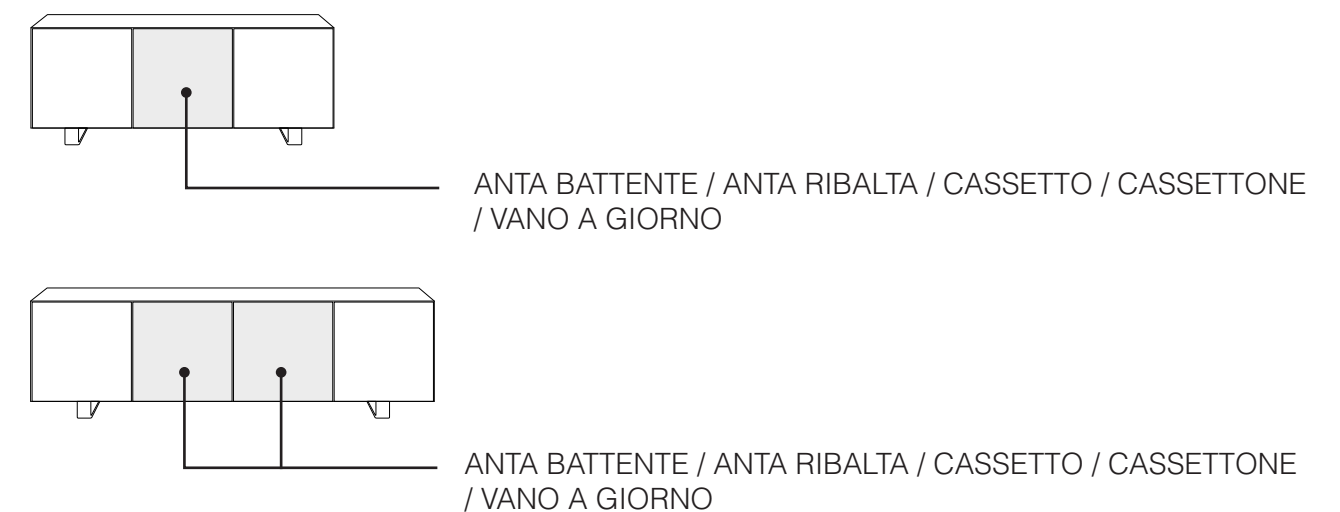

I contenitori centrali nei moduli L 1800 e L 2400 mm possono essere attrezzati con anta battente, ribalta, cassetto, cassettone (forniti con guide Hettich 4D) oppure a giorno della collezione DR-ONE, pag. 277 del listino generale. Il prezzo varierà in base ai contenitori scelti. Non sono previsti tagli a misura.



# SKIN COVER

HP+ CAT. D

DIGITAL PRINT COVER

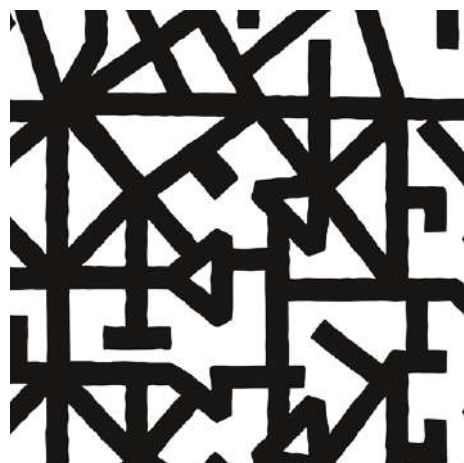

BW\_PN17\_01 scala 1:16

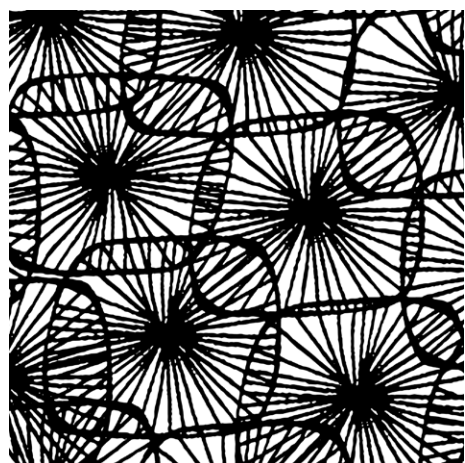

BW\_PN07\_01 scala 1:16



BW\_PN05\_01 scala 1:16

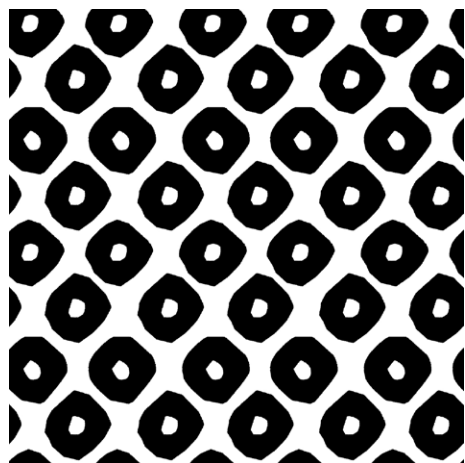

BW\_PN15\_01 scala 1:16

# SKIN COVER

HP+ CAT. D

DIGITAL PRINT COVER (CAT.D)

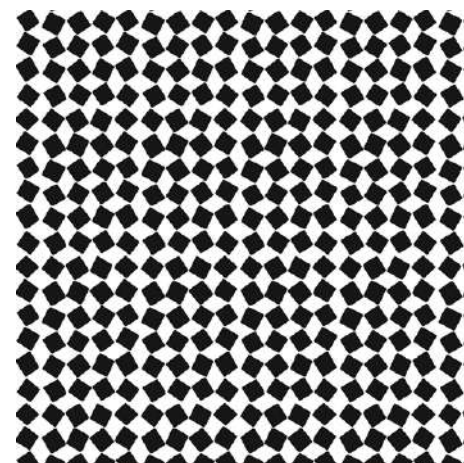
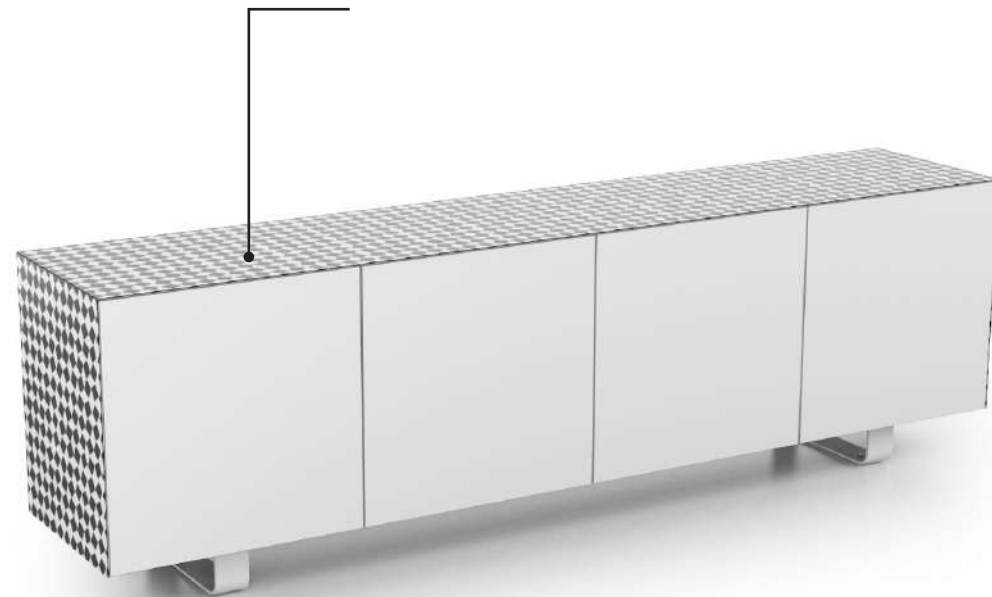

BW\_PN18\_01 scala 1:16

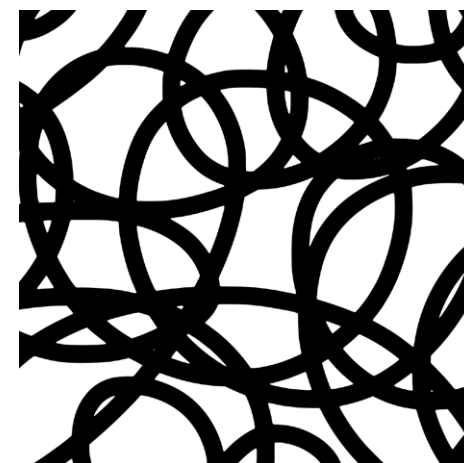

BW\_PN08\_01 scala 1:16

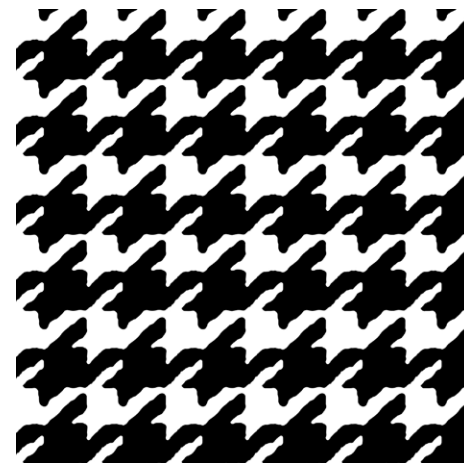

BW\_PN12\_01 scala 1:16

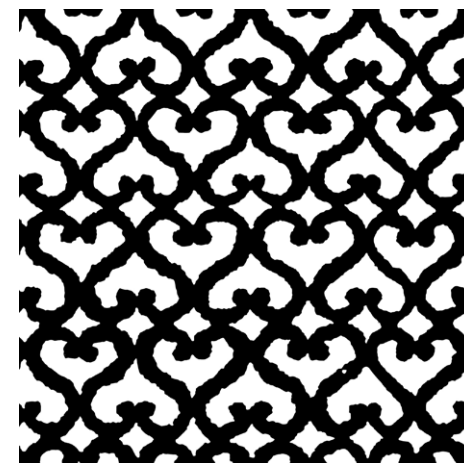

BW\_PN02\_01 scala 1:16

# SKIN COVER

HP+ CAT. D

DIGITAL PRINT COVER

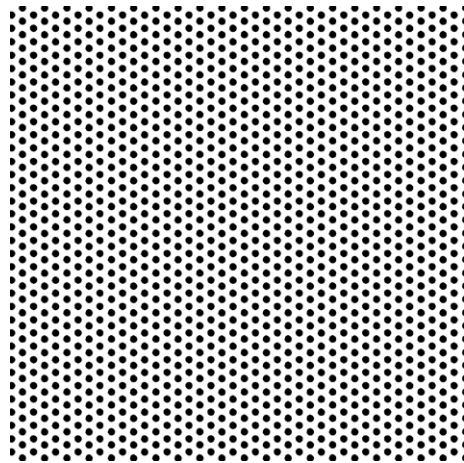
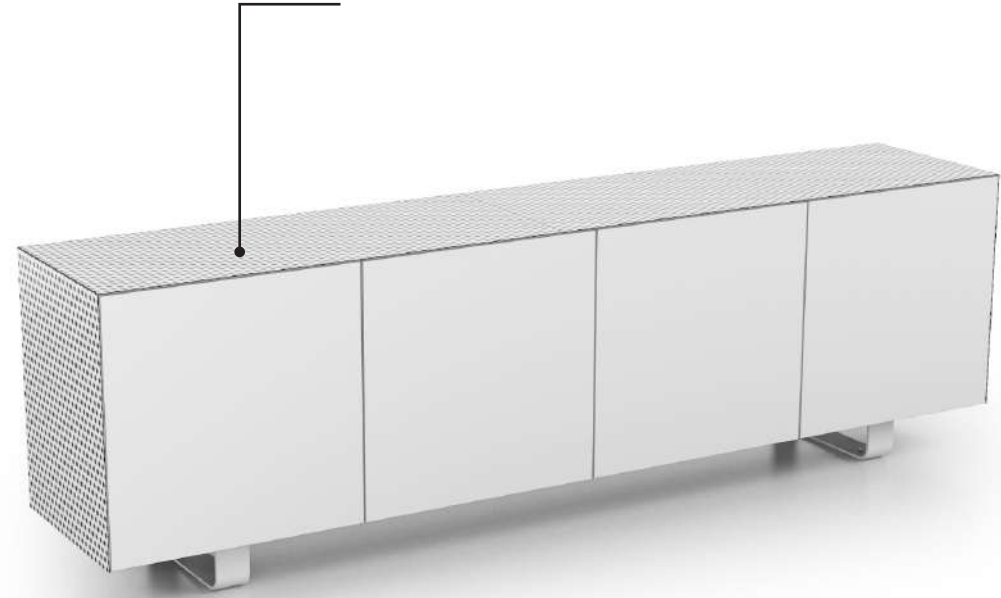

BW\_PN03\_01 scala 1:16

# SKIN





# SKIN





**SKIN COVER**

HP+ CAT. A

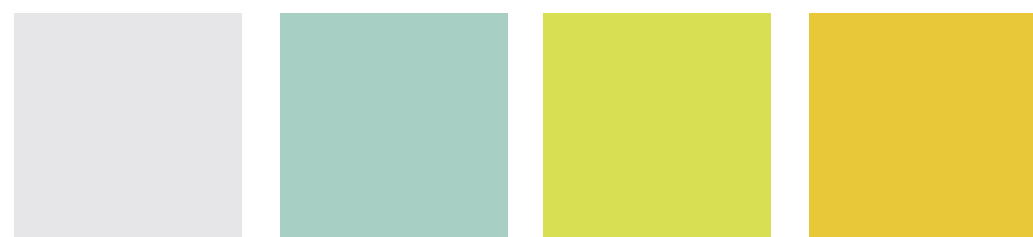
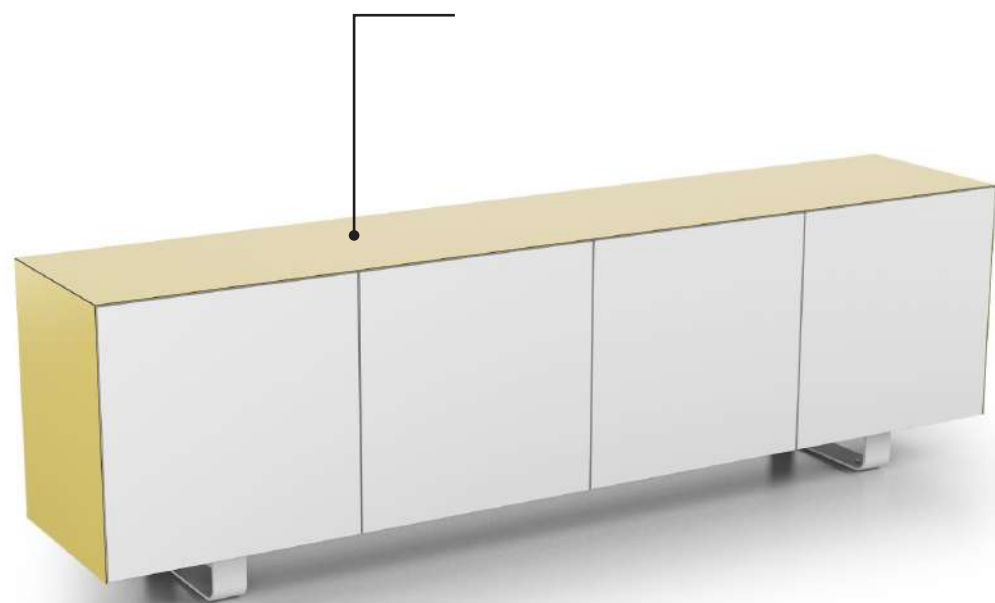
HP+ finitura SEI **COVER**

410

846

1850

469



486

856

496

431

**SKIN COVER**

HP+ CAT. C

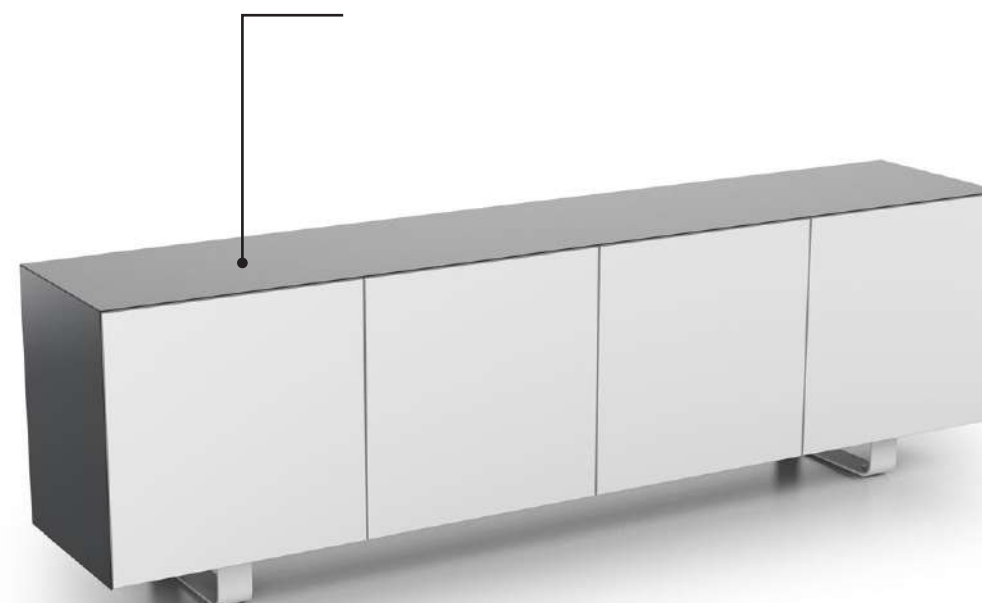
POLARIS **COVER**

002902

002904

002905

002901



002909

002906

002907

002903



# SKIN





# SKIN COVER

HP+ CAT. C

CORTEN & CONCRETE COVER



CE1453



P3276F

# CONTENITORI P+ (colori disponibili)

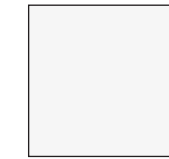
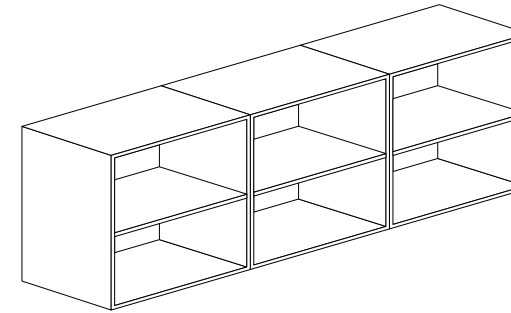

1 - bianco



m - ghirigori bianco



n - ghirigori antracite



u - corda



t - tortora



q - fumé

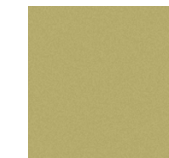

r - oro



2 - nero

# ANTA P+ / HP+ CAT. A / B / C / D (disponibile in tutte le finiture, vedi campionario materiali)

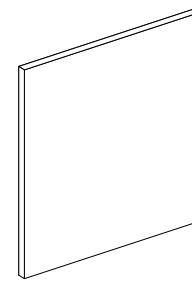

P+

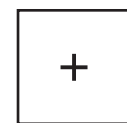
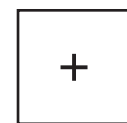
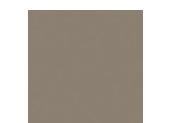
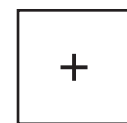
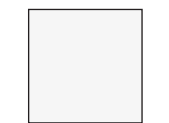

HP+ A

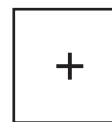

HP+ B

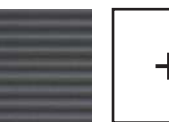
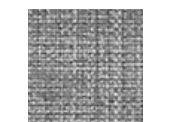

HP+ C

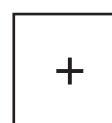
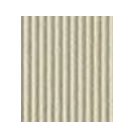

HP+ D

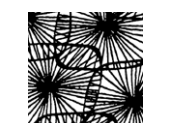
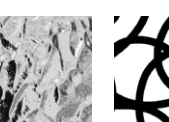



## PRICE LIST - MODULI MONOFACCIALI P 480 / BIFACCIALI P 501 mm

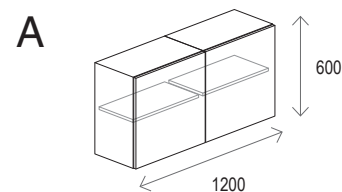

BATTENTE DX-SX				
PVC	CAT. A	CAT. B	CAT. C	CAT. D
424	500	508	528	548

MAGGIORAZIONE SCHIENA BIFACCIALE				
PVC	CAT. A	CAT. B	CAT. C	CAT. D
102	220	260	300	360

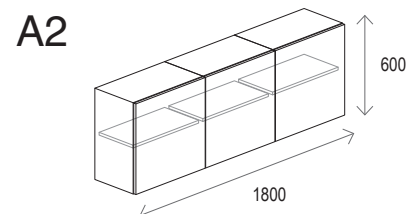

BATTENTE DX-SX				
PVC	CAT. A	CAT. B	CAT. C	CAT. D
636	750	762	792	822

MAGGIORAZIONE SCHIENA BIFACCIALE				
PVC	CAT. A	CAT. B	CAT. C	CAT. D
153	330	390	450	540

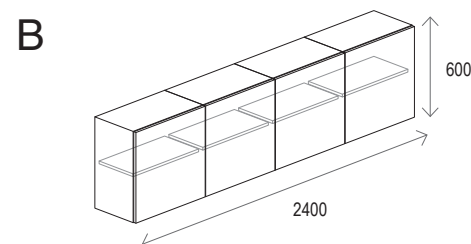

BATTENTE DX-SX				
PVC	CAT. A	CAT. B	CAT. C	CAT. D
848	1000	1016	1056	1096

MAGGIORAZIONE SCHIENA BIFACCIALE				
PVC	CAT. A	CAT. B	CAT. C	CAT. D
204	440	520	600	720

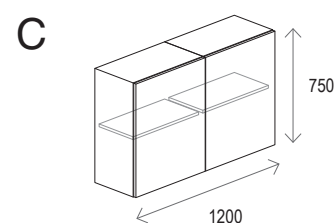

BATTENTE DX-SX				
PVC	CAT. A	CAT. B	CAT. C	CAT. D
460	540	552	574	596

MAGGIORAZIONE SCHIENA BIFACCIALE				
PVC	CAT. A	CAT. B	CAT. C	CAT. D
110	240	300	340	380

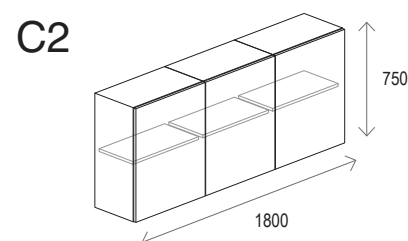

BATTENTE DX-SX				
PVC	CAT. A	CAT. B	CAT. C	CAT. D
690	810	828	861	894

MAGGIORAZIONE SCHIENA BIFACCIALE				
PVC	CAT. A	CAT. B	CAT. C	CAT. D
165	360	450	510	570

## PRICE LIST - MODULI MONOFACCIALI P 480 / BIFACCIALI P 501 mm

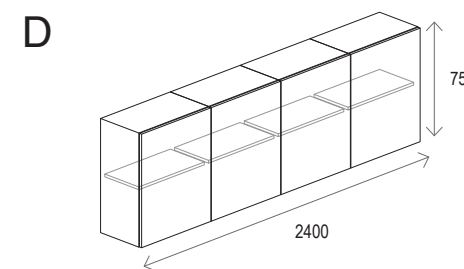

BATTENTE DX-SX				
PVC	CAT. A	CAT. B	CAT. C	CAT. D
920	1080	1104	1148	1192

MAGGIORAZIONE SCHIENA BIFACCIALE				
PVC	CAT. A	CAT. B	CAT. C	CAT. D
220	480	600	680	760

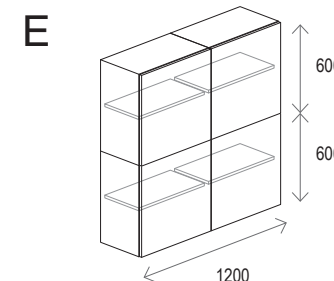

BATTENTE DX-SX				
PVC	CAT. A	CAT. B	CAT. C	CAT. D
848	1000	1016	1056	1096

MAGGIORAZIONE SCHIENA BIFACCIALE				
PVC	CAT. A	CAT. B	CAT. C	CAT. D
204	440	520	600	720

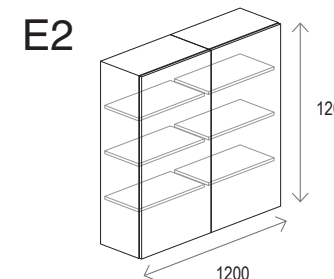

BATTENTE DX-SX				
PVC	CAT. A	CAT. B	CAT. C	CAT. D
678	780	800	838	876

MAGGIORAZIONE SCHIENA BIFACCIALE				
PVC	CAT. A	CAT. B	CAT. C	CAT. D
140	320	360	400	440

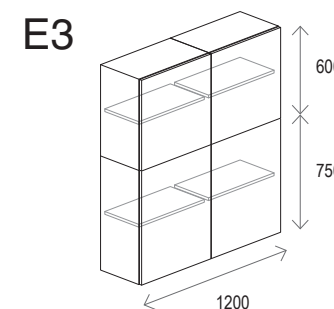

BATTENTE DX-SX				
PVC	CAT. A	CAT. B	CAT. C	CAT. D
884	1040	1060	1102	1144

MAGGIORAZIONE SCHIENA BIFACCIALE				
PVC	CAT. A	CAT. B	CAT. C	CAT. D
212	460	560	640	740

Scocca in P+, ante disponibili in P+ o HP+.



PRICE LIST - SKIN COVER (monofacciale P 480 / bifacciale P 501 mm)

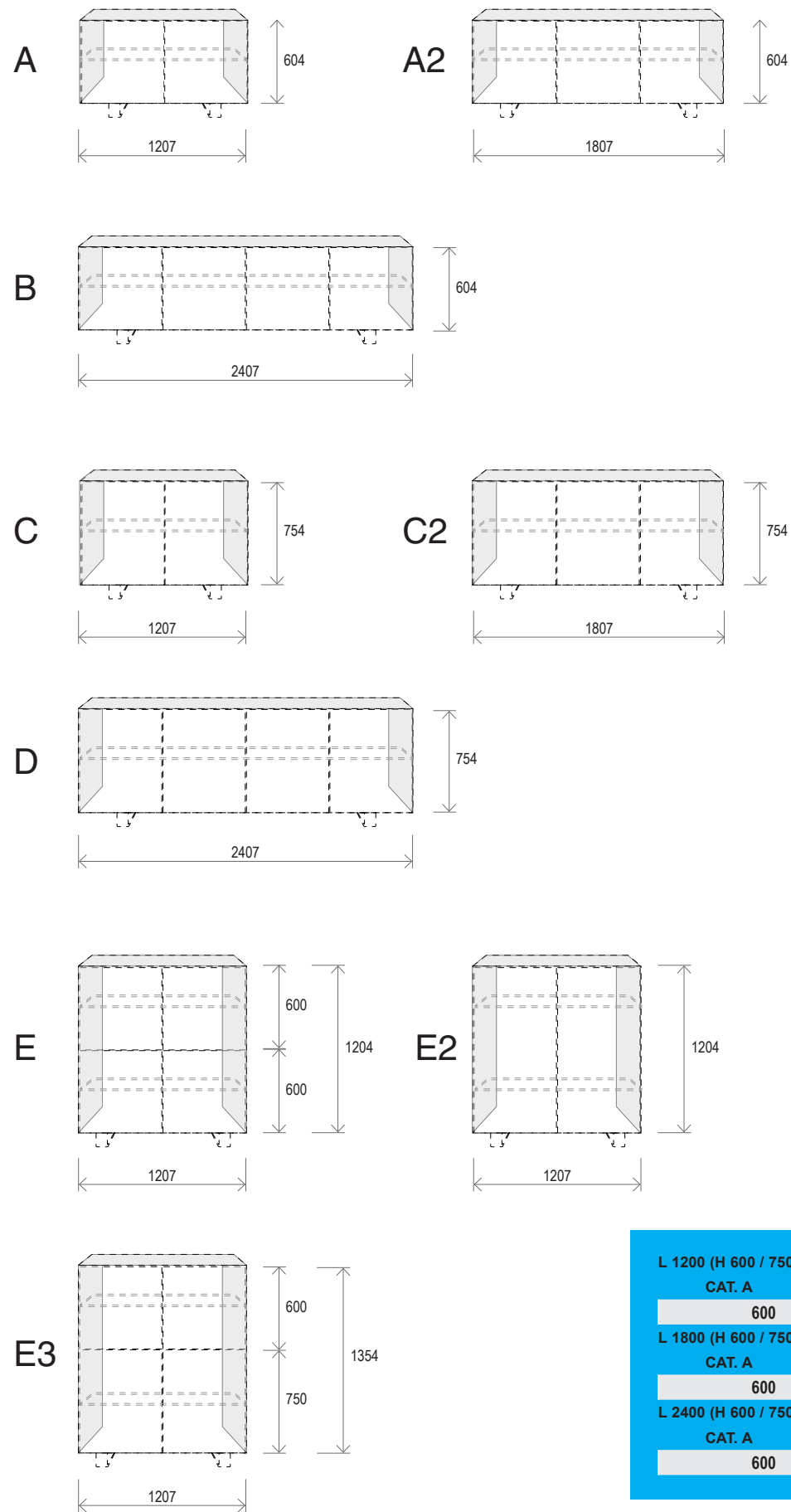

L 1200 (H 600 / 750 / 1200 / 1350)			
CAT. A	CAT. C	CAT. D	
600	680	760	
L 1800 (H 600 / 750)			
CAT. A	CAT. C	CAT. D	
600	680	760	
L 2400 (H 600 / 750)			
CAT. A	CAT. C	CAT. D	
600	680	760	

PRICE LIST - BASAMENTI

BASAMENTO SKIN (H 120 mm)  
in metallo verniciato a polveri epossidiche PE.

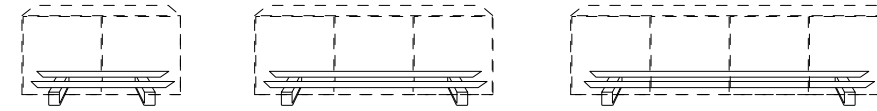

SKIN	PE
L 1200	370
L 1800	384
L 2400	400

BASAMENTO DR-ONE (H 160 mm)  
in metallo verniciato a polveri epossidiche PE.

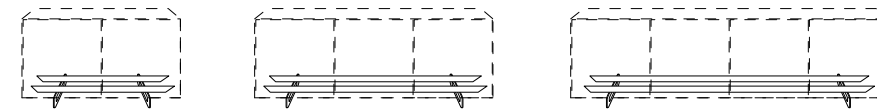

DR-ONE	PE
L 1200	238
L 1800	284
L 2400	318

BASAMENTO "L" (H 120 mm)  
in metallo verniciato a polveri epossidiche PE.

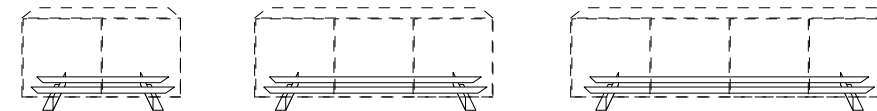

"L"	PE
L 1200	230
L 1800	250
L 2400	280

Basamento in metallo verniciato a polveri epossidiche PE, vedi campionario materiali.





## De Rosso Srl

Via Sernaglia 32/A,  
31010 Farra di Soligo - Tv (Italy)  
Tel. +39 0438 9011  
Fax +39 0438 900146



[www.derosso.it](http://www.derosso.it)

